

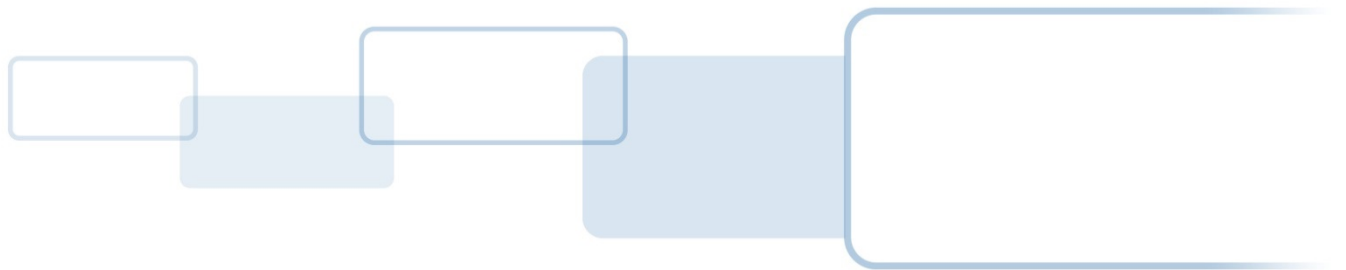

# VertX EVO V1000 Installation Guide

71000-901, Rev. A.4  
July 2016



## Copyright

©2012 - 2016 HID Global Corporation/ASSA ABLOY AB.  
All rights reserved. This document may not be reproduced, disseminated or republished in any form without the prior written permission of HID Global Corporation.

## Trademarks

HID GLOBAL, HID, the HID logo, and VertX are the trademarks or registered trademarks of HID Global Corporation, or its licensors, in the U.S. and other countries.

## Revision History

Date	Description	Version
July 2016	Update to Section 3.4, wiring warning.	A.4
February 2016	Update Global Contacts information and Section 5.1.3.1, password configuration information.	A.3
September 2012	Update Discovery GUI and Virtual Port, Section 2	A.2
July 2011	VertX Installation minus modem	A.1

## Contacts

For additional offices around the world, see [www.hidglobal.com](http://www.hidglobal.com) corporate offices.

<b>North America</b> 611 Center Ridge Drive Austin, TX 78753 USA Phone: 866-607-7339 Fax: 949-732-2120	<b>Asia Pacific</b> 19/F 625 King's Road North Point, Island East Hong Kong Phone: 852 3160 9833 Fax: 852 3160 4809
<b>Europe, Middle East and Africa</b> Haverhill Business Park Phoenix Road Haverhill, Suffolk CB9 7AE England Phone: 44 (0) 1440 711 822 Fax: 44 (0) 1440 714 840	<b>Brazil</b> Condomínio Business Center Av. Ermano Marchetti, 1435 Galpão A2 CEP 05038-001 Lapa - São Paulo/SP Brazil Phone: 55 11 5514-7100

HID Global Customer Support: [www.hidglobal.com/support](http://www.hidglobal.com/support)

## Contents

---

<b>1</b>	<b>Introduction.....</b>	<b>4</b>
1.1	Parts List .....	4
1.2	Product Specifications.....	4
1.3	Cable Specifications.....	5
<b>2</b>	<b>Overview.....</b>	<b>6</b>
<b>3</b>	<b>Connect.....</b>	<b>7</b>
3.1	What you need before getting started.....	7
3.2	V1000 .....	7
3.3	Mounting Instructions .....	7
3.4	Wiring VertX EVO .....	8
<b>4</b>	<b>Contact.....</b>	<b>12</b>
4.1	Discovery GUI (for DHCP networks) .....	12
4.2	Virtual Port.....	12
<b>5</b>	<b>Configure.....</b>	<b>13</b>
5.1	VertX Communications.....	13
5.1.1	Configuration GUI Login.....	13
5.1.2	Basic Network Setup.....	13
5.1.3	Host Communication Setup .....	13
5.1.4	Confirmation .....	14
<b>6</b>	<b>Communicate.....</b>	<b>15</b>
<b>Appendix: A</b>	<b>Troubleshooting.....</b>	<b>16</b>
A.1	System Status .....	16
A.2	Supplemental Configuration .....	16
A.3	Configure .....	16
A.4	System Time.....	17
A.5	Update System.....	17
A.6	Battery Replacement.....	17
A.7	Network Defaults Jumper .....	18
A.8	Firewall .....	19
<b>Appendix: B</b>	<b>Regulatory .....</b>	<b>20</b>
<b>Appendix: C</b>	<b>Configuration Checklist - Static .....</b>	<b>21</b>
<b>Appendix: D</b>	<b>VertX Installation Worksheet.....</b>	<b>22</b>

## 1 Introduction

HID Global's VertX EVO® open platform is flexible and scalable to permit economic and high performance access control solutions for a wide range of applications. The VertX EVO V1000 interconnects through different sub-networks and protocols to a standard TCP/IP network with the capability of a variety of applications.

For example, the VertX EVO Access Controllers are a cost-effective method for two-way communication using Ethernet between a computer and a V1000. In addition, the VertX EVO V1000 communicates through a RS-232 serial port and multi-drop RS-485 ports.

### 1.1 Parts List

Description	Quantity
VertX EVO units (one of the following): V1000 (Access Controller) <b>Note:</b> Each VertX EVO controller has a plastic base and is covered with a plastic lid.	1 V1000 used with any combination of (up to 32) interface panels.
<ul style="list-style-type: none"> <li>Lithium Battery</li> </ul>	1
<ul style="list-style-type: none"> <li>Mounting screws</li> </ul>	4
<ul style="list-style-type: none"> <li>2.2K EOL resistors</li> </ul>	8 ea. V1000
<ul style="list-style-type: none"> <li>Quick Installation Guide</li> </ul>	1
<ul style="list-style-type: none"> <li>Installation Wiring Diagram Example</li> </ul>	1

**Note:** One or more VertX Interface panels are required when installing a VertX EVO V1000 controller.

### 1.2 Product Specifications

Description	Specification
Power Supply	12-24VDC
Maximum Current at 12-24VDC per Unit	1 Amp
Average Operating Current at 12VDC	210mA
Operating Temperature Range	32°-120°F (0°- 49°C)
Humidity	5% to 85% non-condensing
SD Card	Contact System/Software OEM to discuss possible usage and SD Card specifications.
USB Port	Reserved for Future Use

### 1.3 Cable Specifications

Cable Type	Length	Specification
RS-485 *	4000 feet (1220 m) to host	Using Belden 3105A, 22AWG twisted pair, shielded 100Ω cable, or equivalent.
Input Circuits *	500 feet (150 m)	2-conductor, shielded, using ALPHA 1292C (22AWG) or Alpha 2421C (18AWG), or equivalent.
Output Circuits *	500 feet (150 m)	2-conductor, using ALPHA 1172C (22AWG) or Alpha 1897C (18AWG), or equivalent.
Wiegand	500 feet (150 m) to reader	ALPHA 1299C, 22AWG, 9-conductor, stranded, overall shield. Fewer conductors needed if all control lines are not used.
Ethernet	328 feet (100 m)	Cat5, Cat5E, and Cat6
Power Supply 12-24 VDC IN	----	Refer to your Power Supply Installation Guide.

\* Minimum wire gauge depends on cable length and current requirements.

## 2 Overview

The following outlines what is required to install VertX EVO controllers.

### 1 Connect

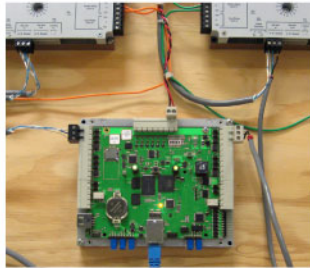

Connect includes:  
Mounting and wiring the controller and interface panels.

### 2 Contact

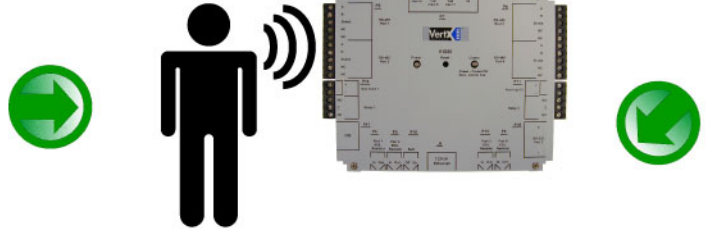

Contact includes:  
Establishing communication with the VertX controller.

### 3 Configure

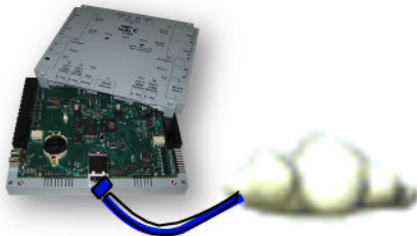

Configure includes:  
Establishing communication so the host software can push down the detailed configuration data.

### 4 Communicate



Communicate includes:  
Contact the host to complete the configuration process.

## 3 Connect

### 3.1 What you need before getting started

Prior to starting the installation, completely read this guide.

See *Section Appendix C: Configuration Checklist - Static*, and gather the information before proceeding with these instructions.

**CAUTION: VertX controllers and panels are sensitive to Electrostatic Discharges (ESD).**

**Observe precautions while handling the circuit board assembly by using proper grounding straps and handling precautions at all times.**

### 3.2 V1000

1. Verify the battery jumper is installed in the ON position, P10 connector.

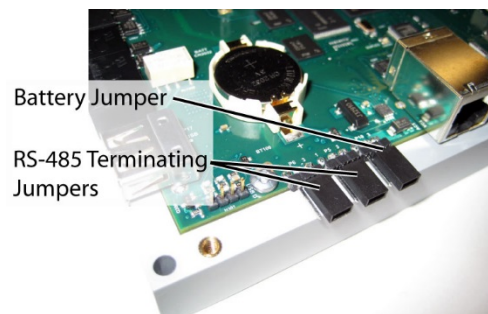

2. If installing a V1000 - Verify the RS-485 termination jumper is in the **Out** position when there are no panels attached to the port. If there are downstream interface panels attached, place the termination jumper in the **In** position. The V1000 is shipped with jumpers in the **Out** positions.

**Note:** P6 controls Port 2 and P5 controls Port 1. This is an issue if one of the jumpers is in the IN position and the other is in the OUT position.

### 3.3 Mounting Instructions

1. Always mount the controllers and interface panels in a secure area.
2. Mount using the four mounting screws (provided) or other appropriate fasteners. Place the fasteners in the corner holes of the base.
3. Stack the VertX EVO devices with or without the cover. Do not remove the plastic base. Position the VertX EVO devices in such a way as to provide room for wiring, air-flow and cable runs.

**CAUTION: Stacking the VertX EVO devices without the cover in place risks the danger of breaking the LEDs unless spacers are used for separation.**

### 3.4 Wiring VertX EVO

**WARNING: VertX EVO V1000 is a NON-PoE device. DO NOT connect J1 (Ethernet port) to a PoE capable port. This applies to both direct PoE Power Sourcing Equipment (Endspan PSE) and PoE injector (Midspan PSE) equipment. Not all PSE's correctly detect Non-PoE-capable devices, and such PSE's may not function as expected when connected to Non-PoE equipment. If the only option is to connect the controller to a PoE enabled port, disable power of the PoE port before connecting.**

**Note:** Carefully peel the attached Warning Label from the bottom of the unit and leave the label attached to the unit's cover for future reference.

**CAUTION: Connectors on the VertX EVO devices are positioned to be mirror images and are not interchangeable once the installation is complete. Therefore, you cannot unplug a connector from one side and plug it into the corresponding connector on the other side.**

1. **Network Connection:** Connect the VertX EVO V1000 to the network using a standard Cat5 network patch cable. Connect one end of the Cat5 network patch cable to the J1 (RJ-45) connector on the V1000 and the other end to the network connection point (network jack, hub, switch, or router) on your site.

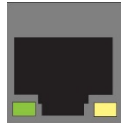

**Note:** Two LED lights exist on the RJ-45 connector. The green LED denotes Ethernet Activity and the yellow LED denotes speed. When the Yellow LED is on, it indicates 100 Mbits per second. Another LED in-board is a Duplex LED, indicating duplex communications are available.

2. **Power and Alarm input connections (All VertX EVO units):** Connect power by providing appropriate DC input to the **P7** connector. Appropriate DC input goes to **Pin 1** and ground to **Pin 2**. Batt Fail, AC Fail, and Tamper switch inputs are wired as shown in the table. Connect the Bat Fail and AC Fail inputs to battery low/failure and AC failure contacts provided on the power supply. Connect the Tamper input to a tamper switch on the enclosure.

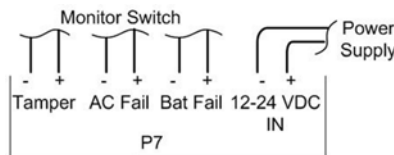
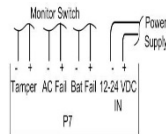

Pin #	P7
1	12-24VDC
2	Ground
3	Bat Fail -
4	Bat Fail +
5	AC Fail -
6	AC Fail +
7	Tamper -
8	Tamper +



3. **RS-485 Connections:** The V1000 has two RS-485 connectors and uses the 10-pin connector on **P3** and **P4**. Each RS-485 bus can support a maximum of 16 V100-Series panels using one or two ports.

Having two ports on each bus provides the option of splitting each RS-485 bus into two physical connections, allowing a total of four physical connections for the two busses.

RS-485 busses must be connected in a daisy chain topology and not a star topology.

The V1000 RS-485 termination jumper should be in the **Out** position if there are no panels attached to the port. If there are downstream panels attached then the termination jumper should be in the **In** position.

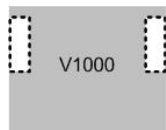

PCB Pin #	V2000 P1	PCB Pin #	V1000 P4 (port 3 and 4)
1	A	10	A
2	B	9	B
3	Shield	8	Shield
4	Not in use	7	Not in use
5	Not in use	6	Not in use
6	A	5	A
7	B	4	B
8	Shield	3	Shield
9	Not in use	2	Not in use
10	Not in use	1	Not in use

**CAUTION: The V1000 RS-485 Ports 1 & 2 (P3) are a common bus and therefore cannot have panels with duplicate Interface Addresses assigned. The same is true of the V1000 RS-485, Ports 3 & 4 (P4). For example, two panels, both with Interface Address 0 (factory default), cannot be connected to Ports 1 and/or 2 (P3).**

Wire the RS-485 to the **In** position only of the P9 terminal block for the V100-Series panel. This is especially important when the RS-485 communication is in a “daisy chain” configuration. If the RS-485 is wired **In** and **Out**, and power is lost, or the P9 terminal block is unplugged on a V100-Series panel, RS-485 communications will be lost to downstream V100-Series panels.

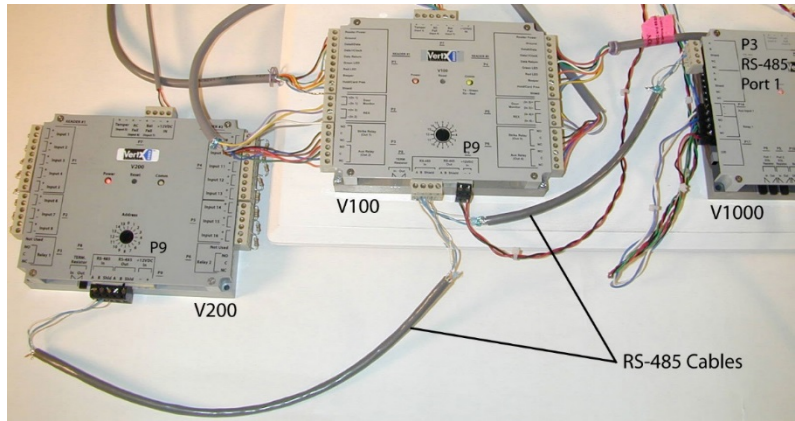

4. **Output Connections (VertX EVO V1000):** All Output connections are used for general purpose controls. The following table shows where the various outputs are located. Pin numbers shown use the convention “NO/C/NC”.

For example, Output 1, V1000: P14 Pin 3 is NO (Normally Open) Pin 4 is C (Common) and Pin 5 is NC (Normally Closed).

**Note:** Relays are dry contact rated for 2Amps @ 30VDC.

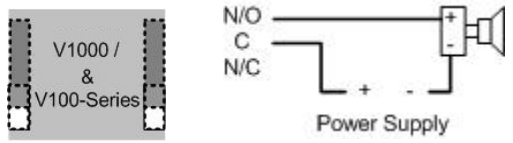

Output Number	V1000
1	P14 Pins 3/4/5
2	P11 Pins 3/4/5

**CAUTION:** Some magnetic locks exhibit both high in-rush current when activated and a high instantaneous break voltage when de-energized due to magnetic field collapse. Use a snubber circuit across the controlling relay terminals to protect the controlling relay contacts. Go to [support.hidglobal.com](http://support.hidglobal.com), see Solution 891 - How do I wire a High In-Rush Current locking device to VertX/Edge/Edge Solo?

5. **Input Connections:** Input connections are analog inputs used for a combination of specific functions such as Request-to-Exit (REX), Door monitor, etc. They can also be used as general purpose monitoring. Connect one side of the switch or contact to the + (plus) lead and the other to the - (minus) lead. The following table shows where the inputs are located. Pin numbers shown on the cover use the convention +/-.

The default REX input configuration is normally open (NO) unsupervised (no EOL resistors).

However, the default Door Switch (DS) configuration is Normally Closed (NC), unsupervised (no EOL resistors).

All other input points are defaulted for NO switches and are unsupervised (no EOL resistors).

Any input can be configured as NO or NC, as well as unsupervised or supervised.

They can be configured for supervisory resistors of 1K - 6K Ohm. The setup of supervised inputs should be done during configuration of the VertX EVO devices through the host.

**Example:** Input 1, V1000 is: P14 Pin1 is + (plus) and Pin 2 is - (minus).

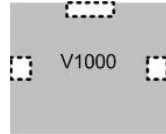

Except for the door monitor, all other inputs default to NO, unsupervised:

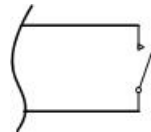

Supervised inputs can be configured for:

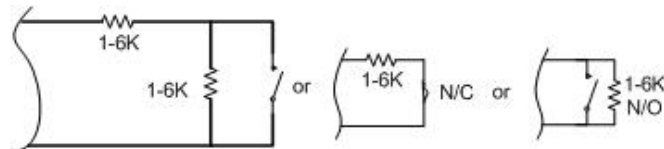

Input Number	V1000
1	P14 Pins 1/2
2	P11 Pins 4/3
3	P7 Pins 8/7 - <i>Tamper</i>
4	P7 Pins 6/5 - <i>AC Fail</i>
5	P7 Pins 4/3 - <i>Batt Fail</i>

## 4 Contact

---

Contact the VertX controller through the following methods.

- Discovery Client (DHCP or Static TCP/IP Configurations Only)
- Virtual Port

### 4.1 Discovery GUI (for DHCP networks)

The Discovery Client provides a technician with a method of locating all of the VertX controllers that are connected to a network. Controller information is displayed providing the ability to 'blink' the VertX controller Comm LED and configure the unit by launching a browser pointed at the Configuration GUI of the targeted controller. When the Discovery Client is launched, a discover command is issued and the Configuration GUI screen is populated with the results. Also provided is the ability to refresh the Configuration GUI screen on command.

Use this feature when the VertX controllers and network have been installed and are operational, but before the VertX controller(s) has been configured. At this point, all of the controllers on a network will have the same host name and unknown IP addresses (assuming a DHCP environment). In this scenario, the only mechanism available to configure a controller is the serial debug port or by only placing one controller on the network at a time. The Discovery Client provides an easy to use mechanism to configure controllers.

**Note:** The Controller must be connected to the network before power is applied for DHCP to function.

1. With the PC connected to the same network as the Controller, double-click **hid-discovery.exe**.
2. Select the device from the list.
3. Click the **Browser**. If the Discovery GUI is not on the PC, download the application from [www.hidglobal.com/downloads/DiscoveryClient.zip](http://www.hidglobal.com/downloads/DiscoveryClient.zip).  
**Note:** Java is required for the Discovery GUI.
4. Go to *Section 5: Configure*.

### 4.2 Virtual Port

Contact a VertX controller by directly connecting the computer to the controller using an Ethernet cable. By default, every controller is configured to respond to a fixed address: **169.254.242.121**.

1. Ensure you are running a Windows 2000 or XP computer.
1. Disconnect your Windows computer from its hub or network.
2. Connect the Windows computer to the controller with an Ethernet cable.
3. Select the Windows **Start > Run**.
4. Enter **ipconfig /renew**. Wait for DHCP to timeout (approximately 60 sec.). The computer will acquire a **169.254.x.x** address.
5. Access a web browser and enter **169.254.242.121** into the **Address** field. The controller is now accessible through this Virtual Port.

## 5 Configure

---

This section describes the communications configuration that enables the controller to communicate with the host software.

There are two methods of communication possible on a V1000 controller:

- Dynamic Host Configuration Protocol (DHCP) TCP/IP Addressing
- Static TCP/IP Addressing. See *Section Appendix C: Configuration Checklist - Static* for a list of criteria needed for a Static TCP/IP configuration.

Enter only the configuration that relates to your sites specific installation.

### 5.1 VertX Communications

The VertX communications configuration is provided through a browser-based application called the **Configuration GUI** (Graphic User Interface).

#### 5.1.1 Configuration GUI Login

1. The Login screen for that controller displays.
2. In the User name field, enter admin (leaving the Password field empty).
3. Click **OK**.

#### 5.1.2 Basic Network Setup

Select the **Connection Selection** option to establish Network connection.

Default network information loads. Before making changes, review the default network information.

**Note:** Most configurations will **not** require accessing the **Advanced Setup** window.

##### 5.1.2.1 Static Network

If using a Static TCP/IP network, proceed with changes using the information collected on the Configuration Checklist. See *Section Appendix C: Configuration Checklist - Static*.

##### 5.1.2.2 DHCP Network

If using a DHCP TCP/IP network, this information is configured automatically.

#### 5.1.3 Host Communication Setup

Enter the **Host Name**, and the **Here I Am Interval** collected on the Configuration Checklist. See *Section Appendix C: Configuration Checklist - Static*.

##### 5.1.3.1 Controller Login Password

During your first instance of accessing the Configuration GUI, you must change the password (located at the bottom of the screen). Enter a new password, and reenter the password in the second field.

**Note:** This step is not necessary during any consecutive Configuration GUI sessions. However on consecutive sessions the password may be changed by the user. The password must be between 6 to 10 characters long and can include all printable ASCII characters from 32 to 126 (decimal) inclusive That is ' ' through to '~' , see <http://www.asciitable.com>.

Extended ASCII such as £ (pound) and € (euro) are NOT supported as they lie outside of the original ASCII range.

Once configuration changes have been made, click **Submit**, and the **Confirmation** window displays. See *Section 5.1.4: Confirmation*.

#### 5.1.4 Confirmation

Once configuration changes are complete and submitted, the **Confirmation** screen will display. Verify that the changes submitted are accurate, and click **Save**. If the changes submitted are not accurate, click **Cancel** and adjust the settings appropriately.

The screenshot shows a confirmation window for the VertX controller. At the top left is the VertX HID logo. Below the logo, the text reads: "The basic setup entries are listed below." This is followed by a red instruction: "The parameters that were changed appear as shown in this text." The settings are organized into three sections:

- Connection Selection**: Connection Type: Network
- Basic Network Setup**: VertX Addressing: Static; IP Address: 10.7.6.134; Subnet Mask: 255.0.0.0; Default Gateway: 10.7.0.1; Primary DNS Server: 10.7.2.220; Secondary DNS Server: 10.7.2.221
- Basic Central Station/Host Communications Setup**: CS/Host IP Address: 10.19.4.130; Here I Am Interval (sec): 60

At the bottom, a message states: "Select Save to confirm the network settings and the VertX controller will be configured as listed above, or select Cancel to reconfigure." Two buttons, "Cancel" and "Save", are located at the bottom center. A mouse cursor is pointing at the "Save" button.

## 6 Communicate

---

Now that the controller is connected, contacted and configured, communicate with the controller using the host.

**Basic setup is now complete!**

Additional troubleshooting tools are available on the System Status and Supplemental Configuration windows. See *Section A.1. System Status* and *Section A.2 Supplemental Configuration*.

## Appendix: A Troubleshooting

---

### A.1 System Status

System Status provides a technician with a method of validating the VertX installation, field wiring and installed devices. Perform the System Status at any time after the VertX controller has been installed and power is available. In addition, a technician may perform a system status as many times as necessary.

Upon startup, the **System Status** window will discover all connected and powered V100-Series devices attached to the controller and displays the inputs, outputs, and host status.

Reference the **Legend** to determine the meaning of the different images.

By clicking **Add Unconfigured** you can configure the V1000 for the attached panels and readers. The assumption is that two readers are attached to any V100 interface panel and that both readers are Wiegand card only. Once the configuration is complete, the VertX software will refresh.

Once the window refreshes, a **Restore Previous** button becomes available.

The **Restore Previous** button enables the technician to use the previously saved configuration.

### A.2 Supplemental Configuration

Supplemental Configuration provides the ability to view and configure system inputs and outputs.

These buttons provide navigation to the following functionality:



**Configure** - configure inputs, outputs and door characteristics for a V1000, V100, V200, and V300.



**System Time** - update System Time



**Update System** - updates the interface board's firmware

### A.3 Configure

Configure provides the ability to view and modify system inputs and outputs and door characteristics.

Upon successful validation, the **Save** button will write modified values to the interface panel.



## A.4 System Time

System Time provides the ability to view and set the date, time, and time zone values on the controller.

Upon initialization, Date, Time, Time Zone and TZ fields will be populated with the current system settings. The date displayed (non-text box) will be updated approximately every 30 seconds.

The **Time Zone** field provides a drop-down menu. One of the options in the **Time Zone** drop-down menu is **Custom Time Zone**. If **Custom Time Zone** is selected, the **TZ** text box will be enabled. Otherwise, the TZ is associated with the **Time Zone** field.

## A.5 Update System

Update System allows the user to update the firmware on the interface panel. During a download the interface panel image flashes between grey and yellow. When a download completes the image color changes to green for successful or red for failure. If the download fails, view a tool tip with the error status code by hovering your mouse over the image in question.

Initially, all of the interface panels are selected by default to be updated.

**Note:** Depending on the VertX controller and system, it may take several minutes to complete a download.

## A.6 Battery Replacement

Do not replace the battery while power is applied to the VertX EVO Controllers.

Remove the cover.

Insert the battery (with the + (positive) side facing upwards) under the prongs, lowering the opposite side into place. Reinstall the cover.

To remove the battery, remove cover, lift the side opposite from the prongs first and slide the battery out of place away from the prongs. Reinstall the cover.

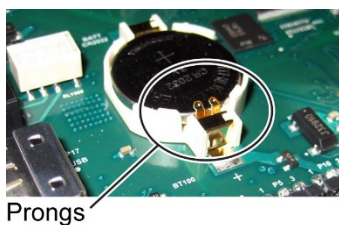

## A.7 Network Defaults Jumper

The **Network Defaults Jumper** requires that someone with physical access to the V1000, place a jumper over the Debug port while the controller is rebooting, as detailed below. The controller reconfigures its network settings to the factory defaults when the jumper is on the Debug port during a reboot. From this point, configuration (or re-configuration) proceeds normally.

Use the Network Defaults Jumper to correct potential errors in a VertX controller's network configuration.

A jumper is supplied with the V1000, and is located across pins 6 & 8 of the Debug port for safe storage. Replace the jumper across pins 6 and 8 for safe storage, after restoring network defaults.

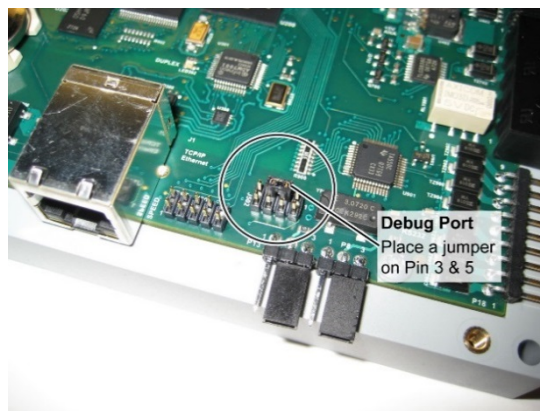

1. Remove the V1000 cover.
2. Reboot the controller and place the supplied jumper over pins 3 & 5 of the Debug port while the Power LED is green.
 

**Note:** The network reset opportunity occurs for 30 seconds while rebooting the controller.
3. After 30 seconds, the Power LED flashes green five times, indicating success. When an error occurs, the LED flashes red five times. In both instances, the LED turns **off** indicating a power cycle is required.
4. Remove the jumper, return it to pins 6 & 8 of the Debug port and cycle power. The controller resets in approximately 60-seconds. Once the reset is complete, the LED returns to green. After the 30-second window, the LED returns to normal Red state. The controller is fully functional during this time.

**CAUTION: During the controller rebooting process, all network configuration information is overwritten and returned to the original defaults.**

5. Configure the controller for your installation parameters. See *Section 5.1: VertX Communications*.
6. Replace the V1000 cover.

## A.8 Firewall

If the VertX controller is being installed where it communicates through a firewall, then the firewall may need to be configured to allow TCP data transfer on the specified port(s).

1. Before starting, ensure that any pop-up blocker software is disabled on the computer.
2. Open the following ports on the firewall.

**connection\_port (4070)** TCP outbound. This port must be open on the Host computer.

**listen\_port (4050)** TCP incoming. This port must be open when using selected applications.

If you are **not** familiar with configuring a firewall for a network, contact the Network/IT administrator or manager.

**CAUTION: If the firewall is not configured properly the controller may not communicate with the host.**

## Appendix: B Regulatory

---

All National and local Electrical codes apply.

- This equipment is intended to be powered from a limited power source output of a previously certified power supply.
- Changes or modifications not expressly approved by the party responsible for compliance could void the user's authority to operate the equipment.

### Class A Digital Devices

**FCC Compliance Statement:** This equipment has been tested and found to comply with the limits for a Class A digital device, pursuant to part 15 of the FCC Rules. These limits are designed to provide reasonable protection against harmful interference when the equipment is operated in a commercial environment. This equipment generates, uses, and can radiate radio frequency energy and, if not installed and used in accordance with the instruction manual, may cause harmful interference to radio communications. Operation of this equipment in a residential area is likely to cause harmful interference in which case the user will be required to correct the interference at their own expense.

### Canada Class A

CE Mark - Europe (EU)  
C-Tick - Australia and New Zealand  
VCCI - Japan  
NCC - Taiwan  
SRRC - China  
IDA - Singapore  
KCC - Korea  
UL Recognized Component (UL294 and UL1076)



This product includes software developed by the OpenSSL Project for use in the OpenSSL Toolkit (<http://www.openssl.org/>).

This product includes cryptographic software written by Eric Young ([eyay@cryptsoft.com](mailto:eyay@cryptsoft.com)).

## Appendix: C Configuration Checklist - Static

Ensure that the Configuration Checklist contents are provided prior to installing a VertX controller with Static TCP/IP.

**Note:** Advanced setting requirements are shown in gray.

Contact			
	Name	E-mail	Phone Number
<input type="checkbox"/>	IT contact		
<input type="checkbox"/>	Sales / PM		
Hardware			
	Name	Source	Part Number
<input type="checkbox"/>	Ethernet Cable		
<input type="checkbox"/>	Computer with Web Browser		
<input type="checkbox"/>	Hub (Optional)		
<input type="checkbox"/>	AC Electrical Outlet or Surge Protector (Optional)		
Configuration Data			
<input type="checkbox"/>	Connection Type	Network (DHCP/Static)	
<input type="checkbox"/>	VertX IP Address	. . .	
<input type="checkbox"/>	Subnet Mask	. . .	
<input type="checkbox"/>	Default Gateway	. . .	
<input type="checkbox"/>	Primary DNS Server	. . .	
<input type="checkbox"/>	Secondary DNS Server	. . .	
<input type="checkbox"/>	Network Broadcast	. . .	
<input type="checkbox"/>	Domain Name		
<input type="checkbox"/>	VertX Host Name		
<input type="checkbox"/>	FTP Enabled	Yes <input type="checkbox"/> No <input type="checkbox"/>	
<input type="checkbox"/>	Telnet Enabled	Yes <input type="checkbox"/> No <input type="checkbox"/>	
<input type="checkbox"/>	Virtual Port Enabled	Yes <input type="checkbox"/> No <input type="checkbox"/>	
<input type="checkbox"/>	Host Addressing (IP Address or Host Name)	. . . OR	
<input type="checkbox"/>	Here I Am Interval (sec)		
<input type="checkbox"/>	TCP/IP Connection Port		
<input type="checkbox"/>	TCP/IP Listen Port		
<input type="checkbox"/>	Login Password	The password must be between 6 to 10 characters long and can include all printable ASCII characters from 32 to 126 (decimal). See <a href="http://www.asciitable.com">http://www.asciitable.com</a>	

## Appendix: D VertX Installation Worksheet

This installation worksheet is provided for you to have a historical record of your system settings. Complete each appropriate field, and keep this worksheet in a safe location.

### Record if the input is wired:

1. **N/O** or **N/C**
2. **Unsupervised** or **Supervised** (resistor values)
3. What type of device is attached?

### Record if output is wired:

1. **N/O** or **N/C**
2. What type of device is attached?

V1000 Information			
Customer Name:		Contact:	
Installed Location:		MAC Address:	
Hostname:		IP Address:	
Tamper:		AC Fail:	BATT Fail:
Input 1:	Input 2:	Relay 1:	Relay 2:
V100 Series Information			
Interface Address: 0-31		Interface Type: V100, V200, V300	
Tamper:		AC Fail:	BATT Fail:
V100 Door / Reader Interface			
Reader 1:		Reader 2:	
Door Switch 1:	REX 1:	Door Switch 2:	REX 2:
Strike Relay 1:	Aux Relay 1:	Strike Relay 2:	Aux Relay 2:
V200 Input Monitor Interface			
Input 1:	Input 2:	Input 3:	Input 4:
Input 5:	Input 6:	Input 7:	Input 8:
Input 9:	Input 10:	Input 11:	Input 12:
Input 13:	Input 14:	Input 15:	Input 16:
Relay 1:	Relay 2:		
V300 Output Control Interface			
Relay 1:	Relay 2:	Relay 3:	Relay 4:
Relay 5:	Relay 6:	Relay 7:	Relay 8:
Relay 9:	Relay 10:	Relay 11:	Relay 12:
Input 1:	Input 2:		

<b>V100 Series Information:</b>			
Interface Address: 0-31		Interface Type: V100, V200, V300	
Tamper:		AC Fail:	BATT Fail:
<b>V100 Door / Reader Interface</b>			
Reader 1:		Reader 2:	
Door Switch 1:	REX 1:	Door Switch 2:	REX 2
Strike Relay 1:	Aux Relay 1:	Strike Relay 2:	Aux Relay 2:
<b>V200 Input Monitor Interface</b>			
Input 1:	Input 2:	Input 3:	Input 4:
Input 5:	Input 6:	Input 7:	Input 8:
Input 9:	Input 10:	Input 11:	Input 12:
Input 13:	Input 14:	Input 15:	Input 16:
Relay 1:	Relay 2:		
<b>V300 Output Control Interface</b>			
Relay 1:	Relay 2:	Relay 3:	Relay 4:
Relay 5:	Relay 6:	Relay 7:	Relay 8:
Relay 9:	Relay 10:	Relay 11:	Relay 12:
Input 1:	Input 2:		





