

# Mini Control Board - Sboard

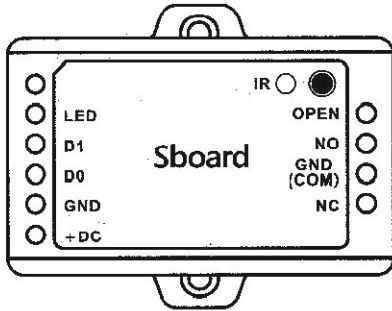

User Manual

## INTRODUCTION

The Sboard is a mini single door control panel, can work with any Wiegand 26-37 bits output reader. It uses Atmel microcontroller to assure stable performance, and equips with an infrared remote control for easy operation. The Sboard supports 1,000 users, all user data can be transferred.

### Features

- > 1,000 users, user data can be transferred
- > Multi access modes: Card, Card or PIN, Card with PIN and multi Cards/PINs
- > Can connect with any reader with Wiegand 26-37 bits output
- > Can connect with any keypad reader with 4bits, 8bits (ASCII), or 10bits Virtual number output
- > Support Master Card function
- > Low temperature resistance(-40°C)

### Specifications

User Capacity	1,000
Operating Voltage	9-24V DC
Idle Current	<20mA
Relay	One (NO, NC, Common)
Adjustable Relay Output Time	1~99 Seconds (5 seconds default)
Lock Output Load	2 Amp Maximum
Wiegand Interface	
Input	Wiegand 26-37 bits
Output	Wiegand 26-37 bits (for user transfer)
Environment	
Operating Temperature	Meets IP66 -40°C ~ 60°C (-40°F ~ 140°F)
Operating Humidity	0-90%RH
Physical	
Colour	ABS Shell Black (White optional)
Dimensions	L65mm × W54mm × D19mm
Unit Weight	40g
Shipping Weight	100g

## Carton Inventory

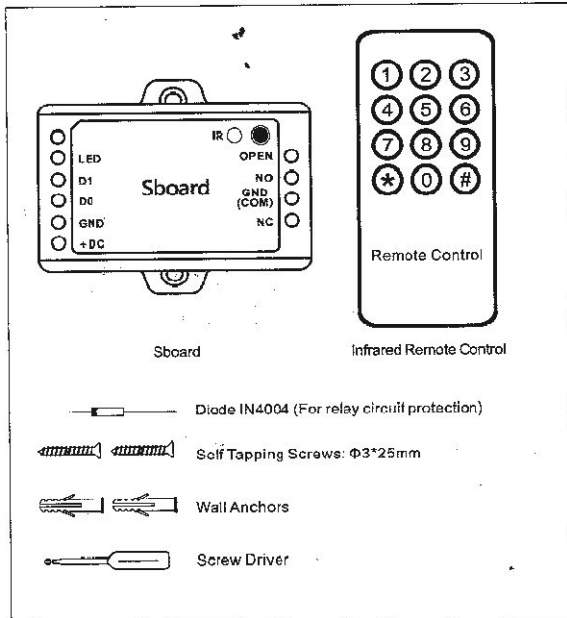

## INSTALLATION

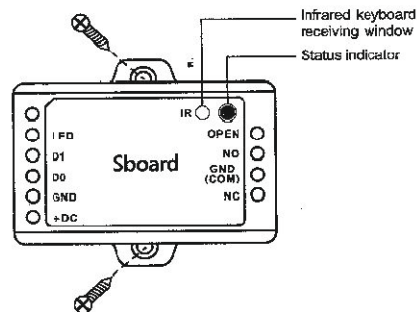

### Wiring

Name	Notes
<b>The Left Side</b>	
LED	Green LED Light Control
D1	Wiegand Input Data 1
D0	Wiegand Input Data 0
GND	Negative Pole of DC (9-24V) Power Input
+DC	Positive Pole of DC (9-24V) Power Input
<b>The Right Side</b>	
OPEN	Connect to One Wire of Exit Button
NO	Normally Open Relay Output (install diode provided)
GND (COM)	Negative Pole of Lock (Common Connection for Relay Output)
NC	Normally Closed Relay Output (install diode provided)

**Sound and Light Indication**

Operation Status	LED	Buzzer
Stand by	Red light bright	—
Enter into programming mode	Red light shines	One beep
In the programming mode	Orange light bright	One beep
Operation error	—	Three beeps
Exit from the programming mode	Red light bright	One beep
Open lock	Green light bright	One beep

**Connection Diagram**

**Magnetic Lock or Fail-safe Lock**

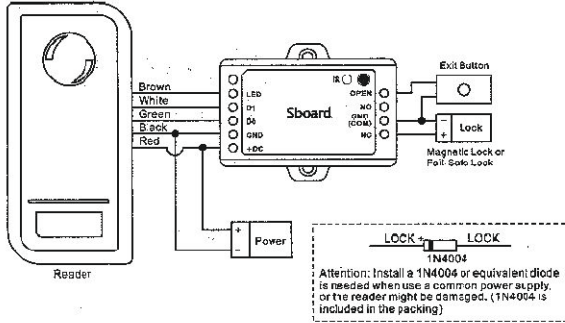

**Door/Gate Operator or Fail-secure Lock**

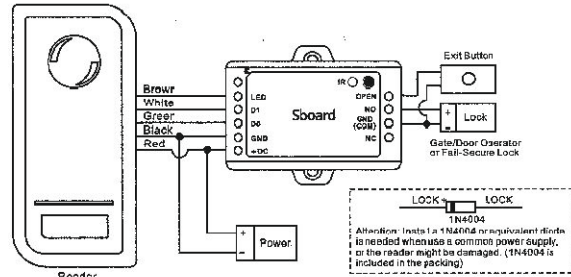

**When Use NO/NC/COM Dry Contact Output**

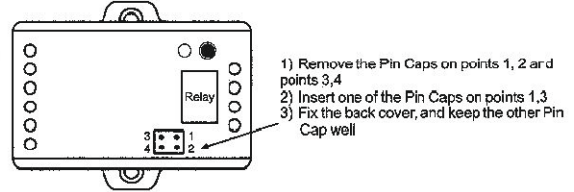

**Remark:**  
The power supply's voltage must be the same with lock's supply voltage, or else, the lock will not work properly or be damaged.

**Reset to Factory Default and Master Cards Programming**

To reset to factory default, power off, press the Exit Button (or connect "OPEN" and "GND" to be short circuit), hold it and power on, there will be two beeps, and the LED light turns into orange, release the exit button (or disconnect "OPEN" and "GND"), then read any two cards on the external reader, the LED will turn into red, means reset to factory default successfully. Of the two cards reading, the 1<sup>st</sup> one is Master Add Card, the 2<sup>nd</sup> one is the Master Delete Card.

**Remarks:**

- ① The Master Cards are not included in the standard packing. The type of the Master Cards is according to the external reader. For example: the external reader is 125KHz HID Reader, then the Master Cards must be 125KHz-HID cards.
- ② If no Master Cards added, must press the Exit Button for at least 10 seconds before release.
- ③ Reset to factory default, the user's information is still retained.

**PROGRAMMING**

Programming will vary depending on access configuration. Follow the instructions according to your access configuration.

**Notes:**

- **Remote Control:** Please use the Infrared Remote Control to program the Sboard. The "IR" on the Sboard is the infrared receiving window, please direct the Remote Control to it.
- **User ID number:** Assign a user ID to the access card in order to track it. The common user ID number can be any number form 0-999. **IMPORTANT:** User IDs do not have to be proceeded with any leading zeros. Recording of User ID is critical. Modifications to the user require the User ID be available.
- **PIN:** Can be any 4-6 digits except 8888 which is reserved.

**Enter and Exit Program mode**

Programming Step	Keystroke Combination
1. Enter Program Mode	* (Master Code) # (Factory default is 123456)
2. Exit Program Mode	*

### Set Master Code

Programming Step	Keystroke Combination
1. Enter Program Mode	* (Master Code) #
2. Update Master Code	0 ( New Master Code ) # ( Repeat New Master Code ) # (code: 6 digits)
3. Exit Program Mode	*

### Add Users with Remote Control

#### Sboard Connected with Card Reader:

For the readers developed together with Sboard, such as S series readers, skip the below step 1; For other card readers, set the Sboard's Wiegand input as below step 1 according to the Wiegand output of the readers.

#### Sboard Connected with Keypad Reader:

Can be any Keypad Reader with 4Bits, 8Bits (ASCII), 10Bits output format. Set the Sboard as below step 1 according to the Wiegand output and PIN output format of the Keypad Reader.

PIN(s) can be Input/added on either the remote control or the external Keypad Reader, except when the Keypad Reader is 10 digits virtual card number output, the PIN(s) can only be Input/added through the Keypad Reader.

### Step 1

Programming Step	Keystroke Combination
1. Enter Program Mode	* (Master Code) #
2. Wiegand Input bits PIN Input bits	8 (26-37) # (Factory default is 26bits) 8 (4 or 8 or 10) # (Factory default is 4bits)
3. Exit	*

Remarks: 4 means 4 bits, 8 means 8 bits, 10 means 10 digits virtual number.

### Step 2

Programming Step	Keystroke Combination
<b>Add Card User</b>	
1. Enter Program Mode	* (Master Code) #
2. Add Card: Using Auto ID (Allows Sboard to assign Card to next available User ID number) OR 2. Add Card: Select Specific ID (Allows Master to define a specific User ID to associate the card to) OR 2. Add Card: by Card Number OR 2. Add Card: Block Learn (Allows Master to add up to 1000 cards to the Reader in a single step.) Takes 2 minutes to program.	1 (Read Card on External Reader) # Repeat Step 2 for additional user cards  1 (User ID) # (Read Card on External Reader) # The user ID is any number from 0-999  1 (Input 8/10 digits Card number) #  1 (User ID number) # (Card quantity) # (The first card number) # Cards' number must be consecutive; Card quantity = number of card to be enrolled
<b>Add PIN User</b>	
1. Enter Program Mode	* (Master Code) #
2. Add PIN: Using Auto ID (Allows Sboard to assign PIN to next available User ID number)	1 (Input PIN) # Repeat Step 2 for additional user cards (PIN: 4-6 digits)
2. Add PIN: Select Specific ID (Allows Master to define a specific User ID to associate the card to)	1 (User ID) # (Input PIN) # The user ID is any number from 0-999 (PIN: 4-6 digits)
3. Exit	*

#### Sboard Connected with Fingerprint Reader:

For example:

Connect F1 as the fingerprint reader to Sboard, two steps to enroll the valid fingerprint.  
(1) Add the Fingerprint (A) on F1  
(2) Add the same Fingerprint (A) on Sboard as below:

1	Enter Program Mode: * (Master Code) #
2	1 (Press Fingerprint A on F1) (Repeat Fingerprint A on F1) # (ID auto allocate)
OR	
2	1 (User ID) # (Press Fingerprint A on F1) (Repeat Fingerprint A on F1) # (Select specific ID)
3	Exit: *

### Add Users by Master Add Card

Add card users

Master Add Card - Read User Card - Master Add Card (Cards can be added continuously)

Add PIN users

Master Add Card - Input PIN - Master Add Card (PINs can be added continuously)

### Change PIN

Programming Step	Keystroke Combination
Note: Below is done outside programming mode, users can undertake this themselves	
1. Change the card associated PIN (There will auto associate PIN 8888 to cards when adding card users)	* (Read Card) (Old PIN) # (New PIN) # (Repeat New PIN) # (PIN: 4-6 digits)
1. Change the users' PIN	* (ID Number) # (Old PIN) # (New PIN) # (Repeat New PIN) # (PIN: 4-6 digits)
2. Exit	*

### Delete User Card(s) or PIN(s) by Remote Control

Programming Step	Keystroke Combination
1. Enter Program Mode	* (Master Code) #

2. Delete User - By User ID OR 2. Delete User - By Card	2 (User ID) #  2 (Read Card on External Reader) #
2. Delete User - By Card number OR 2. Delete User - By PIN OR 2. Delete All User	2 (Input 8/10 digits Card number) #  2 (Input PIN) #  2 (Master Code) #
3. Exit	*

### Delete Users by Master Delete Card

Delete card users

Master Delete Card - Read Card - Master Delete Card (Cards can be deleted continuously)

Delete PIN users

Master Delete Card - Input PIN - Master Delete Card (PINs can be deleted continuously)

### Set Relay Configuration

The relay configuration sets the behaviour of the output relay on activation.

Programming Step	Keystroke Combination
1. Enter Program Mode	* (Master Code) #
2. Pulse Mode  OR 2. Toggle Mode	3 (1-99) # The relay time is 1-99 seconds. (1 is 50mS) (Factory default is 5 seconds)  3 0 # Sets the relay to ON/OFF Toggle mode
3. Exit	*

1	Enter Program Mode: * (Master Code) #
2	1 (Press Fingerprint A on F1) (Repeat Fingerprint A on F1) # (ID auto allocate)
OR	
2	1 (User ID) # (Press Fingerprint A on F1) (Repeat Fingerprint A on F1) # (Select specific ID)
3	Exit: *

#### Add Users by Master Add Card

Add card users

Master Add Card - Read User Card - Master Add Card (Cards can be added continuously)

Add PIN users

Master Add Card - Input PIN - Master Add Card (PINs can be added continuously)

#### Change PIN

Programming Step	Keystroke Combination
<b>Note: Below is done outside programming mode, users can undertake this themselves</b>	
1. Change the card associated PIN (There will auto associate PIN (8888) to cards when adding card users)	* (Read Card) (Old PIN) # (New PIN) # (Repeat New PIN) # (PIN: 4-6 digits)
1. Change the users' PIN	* (ID Number) # (Old PIN) # (New PIN) # (Repeat New PIN) # (PIN: 4-6 digits)
2. Exit	*

#### Delete User Card(s) or PIN(s) by Remote Control

Programming Step	Keystroke Combination
1. Enter Program Mode	* (Master Code) #

2. Delete User - By User ID	2 (User ID) #
OR	
2. Delete User - By Card	2 (Read Card on External Reader) #
OR	
2. Delete User - By Card number	2 (Input 8/10 digits Card number) #
OR	
2. Delete User - By PIN	2 (Input PIN) #
OR	
2. Delete All User	2 (Master Code) #
3. Exit	*

#### Delete Users by Master Delete Card

Delete card users

Master Delete Card - Read Card - Master Delete Card (Cards can be deleted continuously)

Delete PIN users

Master Delete Card - Input PIN - Master Delete Card (PINs can be deleted continuously)

#### Set Relay Configuration

The relay configuration sets the behaviour of the output relay on activation.

Programming Step	Keystroke Combination
1. Enter Program Mode	* (Master Code) #
2. Pulse Mode	3 (1-99) # The relay time is 1-99 seconds. (1 is 50ms) (Factory default is 5 seconds)
OR	
2. Toggle Mode	3 0 # Sets the relay to ON/OFF Toggle mode
3. Exit	*

#### Set Access Mode

For Multi Cards/PINs access mode, the interval time of pressing cards/inputting PINs can not exceed 6S, or else, the machine will exit to standby automatically.

Programming Step	Keystroke Combination
1. Enter Program Mode	* (Master Code) #
2. Card access	4 0 #
OR	
2. Card + PIN access	4 1 #
OR	
2. Card or PIN access	4 2 # (Factory default)
OR	
2. Multi cards/PINs access	4 3 (2-9) #
3. Exit	*

#### Set Audible and Visual Response

Programming Step	Keystroke Combination
1. Enter Program Mode	* (Master Code) #
2. Control Sounds	OFF = 7 0 #      ON = 7 1 #
OR	
2. Control LED	OFF = 7 4 #      ON = 7 5 # (Factory defaults are ON)
3. Exit	*

#### User Information Transfer

The Sboard supports the User Information Transfer function, and the enrolled user (cards, PINs) can be transferred from one (let's name it Master Unit) to another (let's name it Accept Unit). Maximum 10pcs Accepts Units can be transferred once.

#### Connection Diagram:

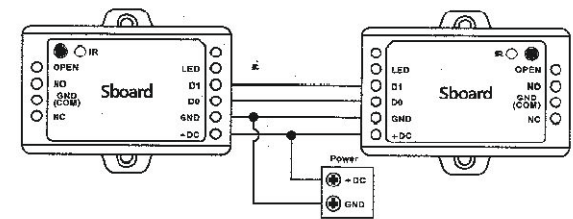

#### Remarks:

- The Master Units and Accept Units must be Sboard or S1234-X.
- The Master Code of the Master Unit and the Accept Unit(s) must be set to the same.
- Program the transfer operation on Master Unit only.
- If the Accept Unit(s) are already with the users enrolled, it will be covered after transfer.
- For full 1,000 users enrolled, the transfer takes 3 minutes.

#### Set Transferring on Master Unit:

Programming Step	Keystroke Combination
1. Enter the programming mode	* (Master Code) #
2. Set transferring	9 6 #
Within 3 minutes, Green LED shines, that means the users' information has been transferred successfully.	
3. Exit	*